

Vertical Turning Lathes

V760EX / 2SP-V760EX
V920EX / 2SP-V920EX



Vertical Turning Lathes

V760EX / 2SP-V760EX ***V920EX / 2SP-V920EX***



With a smaller footprint, the V920EX has a larger work envelope, higher performance, and handles more workpiece applications.

The innovative productivity of large-diameter thin and odd-shaped workpieces makes it ideal for industrial machine parts, as well as large construction and aircraft components.

V920EX



**Minimum installation space,
maximum machining area.
This Okuma vertical lathe provides
the maximum in floor space productivity.**

2SP-V760EX



Machining Area Effectiveness —in a class by itself—

Outstanding productivity per floor space maximizes the benefits of high-performance vertical lathe applications for high production efficiency

Highly accurate, stable machining and high machining capacity. The ease of use of a vertical lathe on a base with Okuma's legendary high-rigidity structure. Greater user-friendliness is achieved together with a smaller footprint and larger machining area.

Stable machining of large workpieces

Stable machining achieved even with difficult-to-chuck thin, large-diameter workpieces and unbalanced, odd-shaped components.

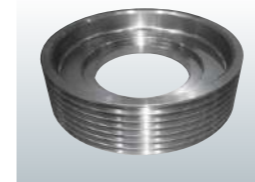

Pulley

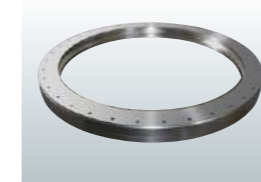

Bearing



Valve body

Very efficient turn/mill operations

With considerably improved turning and milling capacity, the V760EX and V920EX deliver powerful cuts for heavy workpiece applications.

Easy maintenance with outstanding chip collection

Various improvements were made in chip discharge and inspection locations to reduce operator burden and operation time. This shortens daily maintenance and machining preparation time so that operators can focus on the work.

Support for machining close accuracies with decreased operator burden



Okuma's Thermo-Friendly Concept supports dimensional stability at cycle start/restart points, and improves operator work efficiency by requiring fewer dimensional compensation checks.

Innovative shop floor productivity in many types of production

The 2SP-V760EX and 2SP-V920EX combine left-right symmetric L and R machines operating from a single control. This both shortens lead times and uses factory space effectively.

ATC specs are available on the V920EX, preventing interference between the workpiece and adjacent tools and enabling free tool layout.



V920EX

Stable machining of large workpieces

Large machining area can accommodate a wide range of applications

Large machining area achieved with small footprint. Sufficient space (maximum swing: $\phi 800$ mm/V760EX, $\phi 1,000$ mm/V920EX) for chucking of odd-shaped workpieces is also provided, meeting a wide range of customer machining needs.

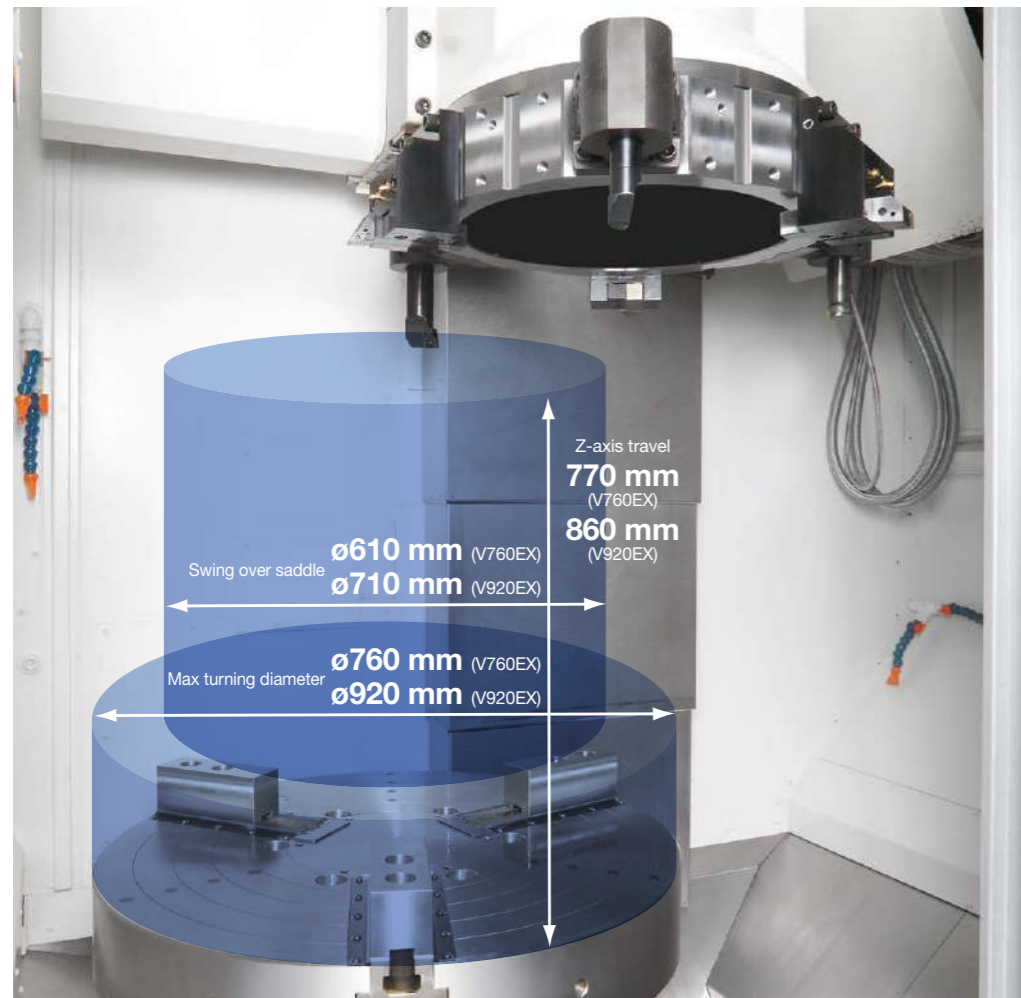

Photo shows the V920EX

The features of vertical lathes provide for highly accurate, stable machining

Since the adhesive weight of a workpiece helps clamp it to the chuck's reference surface. This prevents workpiece warp, and accommodates thin, large-diameter, or heavy workpieces. With fixtures for odd-shaped components, manual part load/unload (without holding the part in place) is also easy.

Machining capacity (actual data)

	V760EX	V920EX
Turning	Heavy-duty cutting: 5.0 mm^2	Heavy-duty cutting: 6.0 mm^2
● OD turning example (S45C)		
Cutting Speed	150 m/min	150 m/min
Cutting depth	10 mm	10 mm
Feed	0.5 mm/rev	0.6 mm/rev

Powerful, high-accuracy machining

Powerful spindle for high-accuracy machining of heavy workpieces.

A flanged headstock minimizes thermal deformation and vibration in the main spindle, enabling high-accuracy cutting.

V760EX/2SP-V760EX

Standard spindle (OSP)

- Spindle speed: $2,000 \text{ min}^{-1}$
- Max output: 30/22 kW (30 min/cont)
- Max torque: 1,257/922 N-m (15 min/cont)

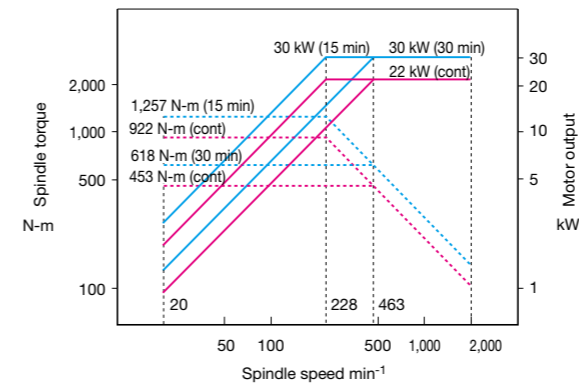

V920EX/2SP-V920EX

Standard spindle (OSP)

- Spindle speed: $1,250 \text{ min}^{-1}$
- Max output: 30/22 kW (30 min/cont)
- Max torque: 2,607/1,738 N-m (20 min/cont)

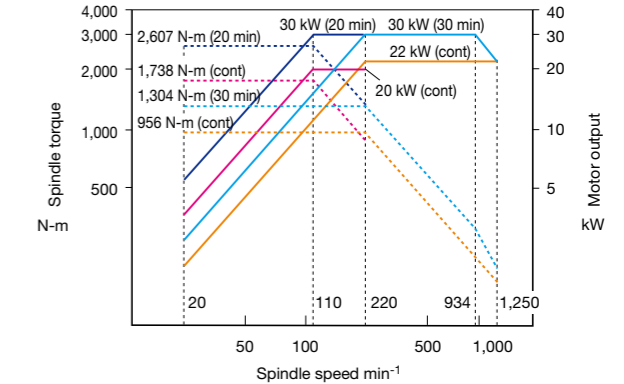

Note: Please refer to pages 17 and 18 for options

Advanced, highly rigid construction enables powerful and very accurate machining

A rock-solid rectangular column is firmly secured to a rigid base with excellent damping performance. Minimal tool-to-column guideway distance assures the rigidity needed to withstand heavy-duty cutting loads. Moreover, the box ways for the X and Y axes help to achieve heavy-duty cutting of big components at high accuracies.

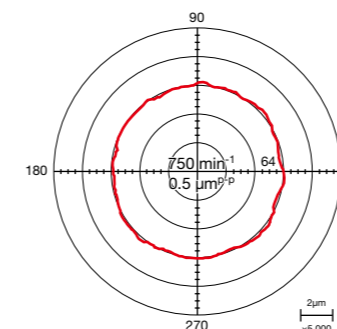

Highly rigid structure with column fixation and saddle movement

Process-intensive machining with powerful milling

More powerful, can use greater number of tools

Turning, drilling, end milling all done on a single machine to accommodate a wide range of applications. A much more powerful milling tool spindle than on previous machines enables more powerful cutting and a wider range of process-intensive machining. The turret minimizes interference with neighboring tools so that milling tools can be attached in all 12 locations.

Applications from turning to milling can be done with a single chucking, reducing the work in progress storage space and between process waiting times. Chucking error during workpiece installation can also be eliminated for higher machining accuracies.



V760EX

V760EX/2SP-V760EX

Milling tool spindle (OSP)

- Spindle speed: 4,000 min⁻¹
- Max output: 7.5/4.3 kW (25 min/cont)
- Max torque: 57.8/33.1 N-m (25 min/cont)

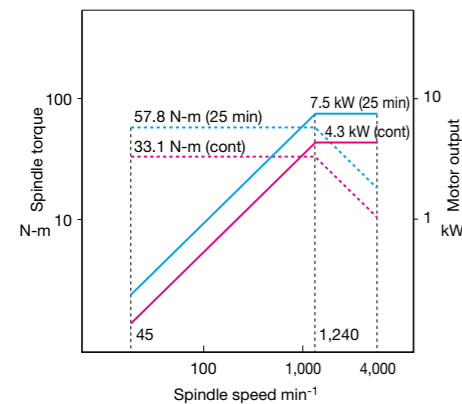

V920EX/2SP-V920EX

Milling tool spindle (OSP)

- Spindle speed: 4,000 min⁻¹
- Max output: 14/7 kW (5 min/cont)
- Max torque: 84/42 N-m (Intermittent/cont)

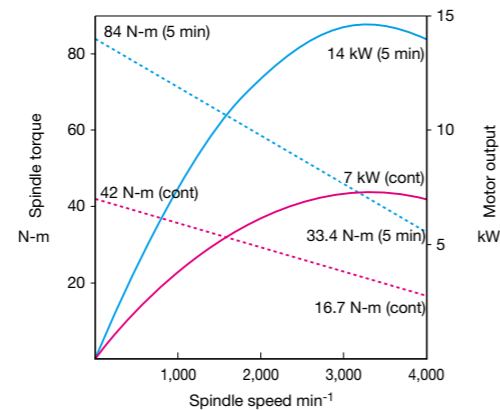

Note: Please refer to page 18 for options

Easy maintenance with outstanding chip collection

Foolproof chip discharge

Standard chip flushing and a stainless steel chute provide for complete chip discharge to the conveyor (Opt) running directly below the turret. That also cuts down machine operator work-flow interruptions to clean out chips.



V920EX

Operator work burden drastically reduced with well-designed workflows

The operator can easily reach the spindle center 552 mm from the front of the machine. (V760EX)
With excellent accessibility the workpiece can be loaded and unloaded smoothly without interference using a crane.

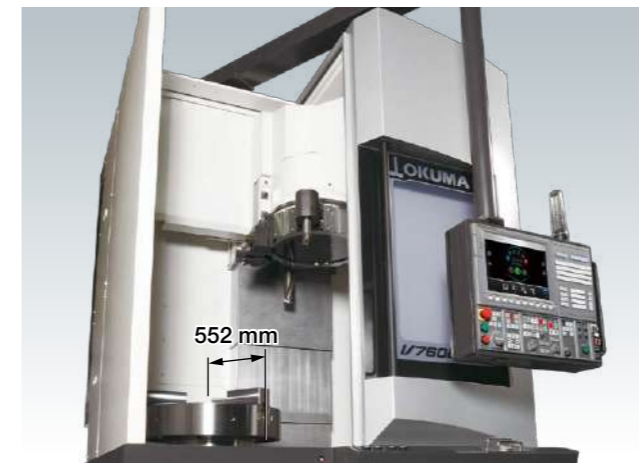

V760EX

Chip discharge system can be adjusted to shop layout requirements

Either side or rear chip conveyors (Opt) can be selected to match chip discharge direction for shop layout.



V920EX Rear chip conveyors

Smoother daily inspections

The air filter, lubricant tank, hydraulic unit and coolant tank are all located on the back of the machine. This shortens the time needed for daily inspections and improves utilization.

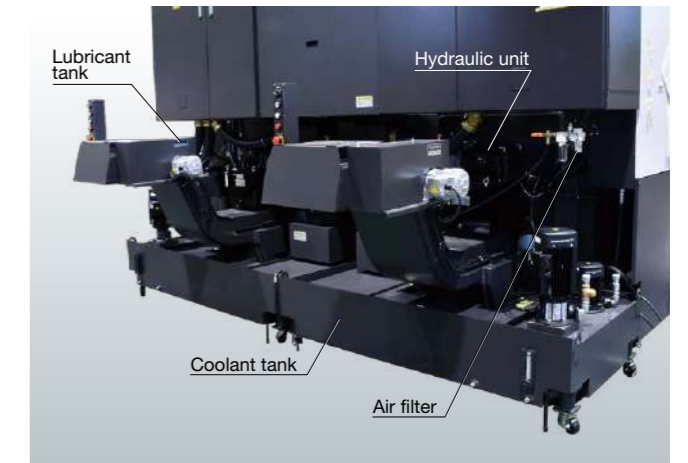

2SP-V760EX

Innovative shop floor productivity in many types of production

High productivity with 2 roles by 1 machine (2SP-V760EX, 2SP-V920EX)

The 2-spindle spec 2SP-V760EX, 2SP-V920EX combines a standard R (right) machine and reverse structure L (left) machine and is operated with a single controller. This gives the maximum productivity with the minimum floor space by shortening lead times and cutting down on intermediate work in progress. The separated right-left structure also enables stable machining that is unaffected by the machining vibration of the other spindle.

- Compact lines that minimize robot travel can be built.



Build automated systems to match your needs

With a design that allows workpiece mounting/dismounting from either the front or side, robots and conveyance equipment can be configured with greater freedom. Flexible, automated systems can be configured in combination with existing equipment.



L (left) machine

R (right) machine

■ Space-saving cells with articulated robots

- Connected cells for 1st and 2nd operations can be constructed in a small space
- Side-shutter part load/unload allows uninhibited operator machine-front access
- Operation status can be checked from machine front

■ Workpiece push-up device, ejector (Optional)

- Machine supports heavy workpiece load/unload operations. Greatly reduces operator burden.
- Operator simply places workpiece on plate above chuck.
- Push-up device automatically raises and lowers workpiece on chuck, and ejector automatically ejects workpiece from machine. (V760EX, 2SP-V760EX machines only)

Increased tool storage capacity with ATC (*Optional only for V920EX)

Interference between workpiece and adjacent tools that occurs when machining near the center of large-diameter workpieces is prevented with automatic change and storage of tools. This dramatically increases freedom in cutting tool layout. Tool setup also becomes easier. Increased tool storage capacity means that more machining can be done without dividing processes.



V920EX ATC Spec

Easy to operate ATC by the button next to ATC magazine.

■ ATC operation

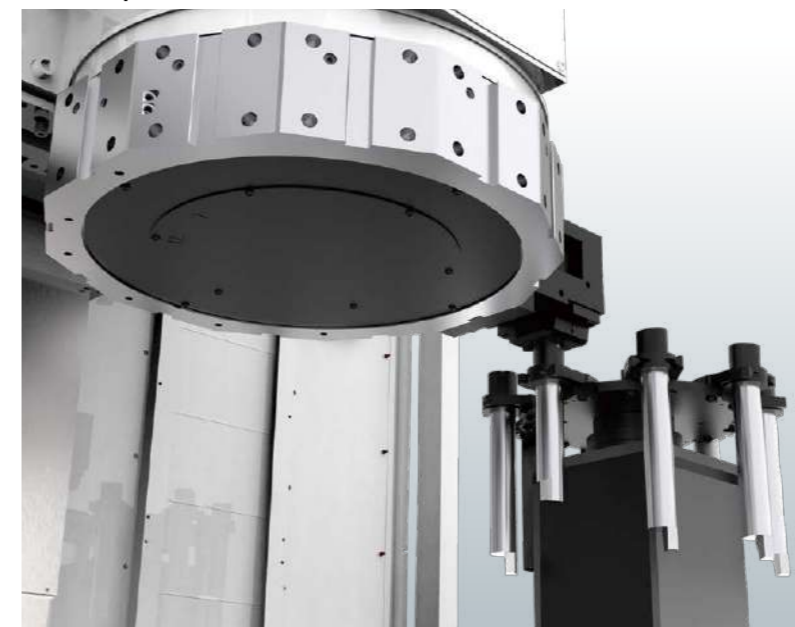

Dedicated station in one location

■ ATC tooling

Standard maximum tool dimensions

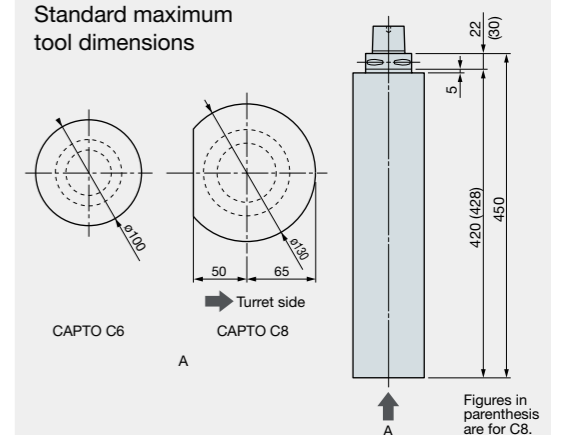

	C6	C8
ATC magazine (only with use of turning tool holder)	12	8
Tool standards	CAPTO C6	CAPTO C8
Max tool length	450 mm	
Max tool weight	10 kg	15 kg

Okuma's Intelligent Technology reduces operator burden



Manageable Deformation—Accurately Controlled Thermo-Friendly Concept

Machining accuracies change significantly due to temperature changes around the machine, heat produced by the machine and heat produced in machining. The Thermo-Friendly Concept adopts the unique approach of “accepting” these temperature changes to provide highly accurate machining in normal factory environments without special equipment or measures to counter temperature changes.

Machining dimensional change over time: Less than: $\pm 8 \mu\text{m}$

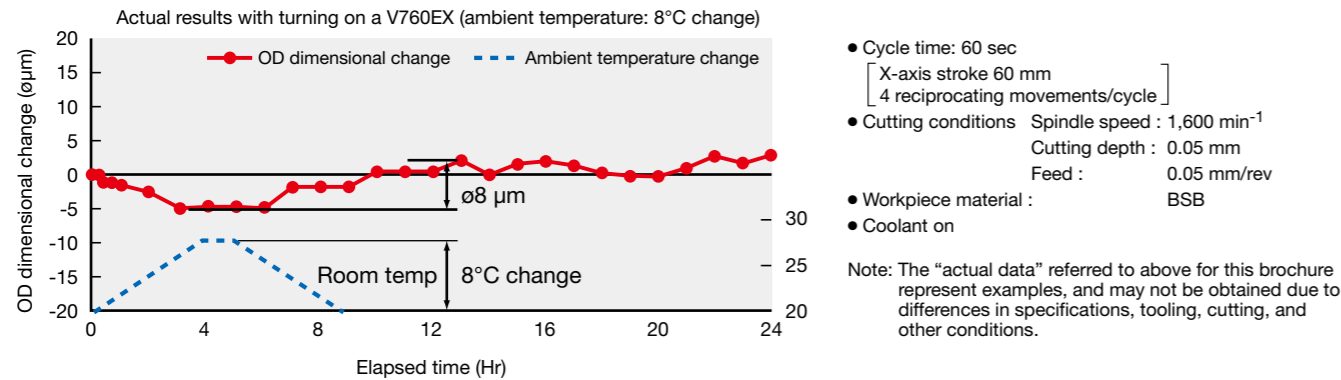

Eliminate waste with the Thermo-Friendly Concept

Okuma's Thermo-Friendly Concept maintains dimensional stability not only when temperature changes, but also during machine start-up and machining restart. Warming-up time is reduced since thermal deformation is stabilized, decreasing the time and effort needed for dimensional compensation during restarts.

TAS-C: Thermo Active Stabilizer—Construction

Thermo Active Stabilizer—Construction (TAS-C) uses information from well-placed sensors and feed shaft information to predict the thermal deformation in machine structure from ambient temperature changes, based on the thermal deformation characteristics of the machine, and finely control the machine.



Cutting condition search Machining Navi L-g (Optional)

Varying the spindle speed in accordance with the best amplitude and period makes it possible to suppress chatter during turning operations. Tool life can be extended and machining time reduced with use of the optimum cutting conditions, producing significant effects in drilling/boring bar, threading, and grooving applications.

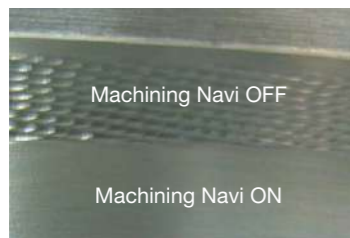

All energy-saving technologies that can be used by a machine are available

ECO suite

- “ECO Idling Stop” for operation of necessary units only
- “ECO Power Monitor” for visual graphic of power
- Intermittent/continuous operation of chip conveyor and mist collector during operation — “ECO Operation” (optional)

With revamped operation and responsiveness— ease of use for machine shops first!

Smart factories implement advanced digitization and networking (IoT) in manufacturing to achieve enhanced productivity and added value. The OSP has evolved tremendously as a CNC suited to advanced intelligent technology. Okuma's new control uses the latest CPUs for a tremendous boost in operability, rendering performance, and processing speed. The OSP suite also features a full range of useful apps that could only come from a machine-tool manufacturer, making smart manufacturing a reality.

Smooth, comfortable operation with the feeling of using a smart phone

Improved rendering performance and use of a multi-touch panel achieve intuitive graphical operation. Moving, enlarging, reducing, and rotating 3D models, as well as list views of tool data, programs, and other information can be accomplished through smooth, speedy operations with the same feel as using a smart phone. The screen display layout on the operation screen can also be changed to suit operator preferences and customized for the novice and/or veteran machinists.



“Just what we wanted.”— Refreshed OSP suite apps

This became possible through the addition of Okuma's machining expertise based on requests we heard from real, machine-shop customers. The brainpower packed into the CNC, built by machine tool manufacturer, will “empower shop floor” management.



Increased productivity through visualization of motor power reserve Spindle Output Monitor

The specified spindle output (red line: short time rating, green line: continuous rating) and the spindle output in current cutting (blue circle) are simultaneously displayed on the screen, for real-time view of power reserve during cutting. This allows speeding up cutting by increasing the spindle speed or feed rate while monitoring the graph to ensure that the blue circle does not cross the lines.



Easy programming without keying in code Scheduled Program Editor



Monitoring operating status even when away from the machine E-mail Notification

Machine Specifications

Item	Unit	V760EX		2SP-V760EX	
		L	M	L	M
Capacity	Max turning diameter	ø760 (29.92)			
	Max swing diameter	ø800 (31.50)			
	Swing on carriage	ø610 (24.02)			
	Max work length (height)	770 (30.31)			
	Max workpiece weight (w/ chuck)	500 (1,100) [When limited to 1,000 kg/200 min ⁻¹]			
	Height from floor to spindle nose*1	1,085 (42.72)			
Travel	X-axis travel	390 (15.35)			
	Z-axis travel	770 (30.31)			
	C-axis travel	Degrees	–	360 (minimum control angle 0.001)	–
Spindle	Spindle speed	20 to 2,000			
	Spindle speed ranges	2 auto ranges (2-speed motor coil switching)			
	Spindle nose shape	JIS A2-11			
	Spindle bore diameter	ø92 (3.62)			
	Spindle front bearing diameter	ø160 (6.30)			
Turret	Turret type	V12	M-V12	V12 + V12	M-V12 + M-V12
	No. of tools	12	L/M: 12	12 + 12	L/M: 12 + 12
	OD tool shank dimensions	□25, □32 (1, 1-1/4)			
	ID tool shank diameter	ø40, ø50, ø63 (1.57, 1.97, 2.48)			
Milling tool	Milling tool spindle speed	–	4,000	–	4,000
	Milling tool spindle torque	–	OSP:57.8/33.1 (25min/cont) FANUC:70/30 (inter/cont)	–	OSP:57.8/33.1 (25min/cont) FANUC:70/30 (inter/cont)
	Milling tool speed range	–	Infinitely variable	–	Infinitely variable
Feedrates	Rapid traverse X, Z-axis	m/min (fpm) X: 24 (78.74), Z: 24 (78.74)			
	Rapid traverse C-axis	–	20	–	20
	Cutting feedrate X, Z-axis	mm/rev 0.001 to 300.000			
Motor	Spindle drive	30/22 (40/30) (30 min/cont)		30/22 (40/30) (30 min/cont) × 2	
	Milling tool spindle motor	–	OSP: 7.5/4.3 (10/5.7) (25 min/cont) FANUC: 5.5 (cont)	–	OSP: 7.5/4.3 (10/5.7) (25 min/cont) FANUC: 5.5 (cont)
	Axis drive motors	OSP X: 3.5 (4.7), Z: 4.6 (6.1) FANUC X: 4.0 (5.3), Z: 4.0 (5.3)	OSP X: 3.5 (4.7), Z: 5.2 (6.9) FANUC X: 4.0 (5.3), Z: 4.0 (5.3)	OSP X: 3.5 (4.7), Z: 4.6 (6.1) FANUC X: 4.0 (5.3), Z: 4.0 (5.3)	OSP X: 3.5 (4.7), Z: 5.2 (6.9) FANUC X: 4.0 (5.3), Z: 4.0 (5.3)
	Coolant pump motors (50 Hz/60 Hz)	Turret: 0.25/0.25 (0.3/0.3) shower: 0.37/0.55 (0.5/0.7)			
Machine Size	Machine height*1	mm (in.) 3,489 (137)			
	Required floor space (length × width)*2	mm×mm (in.) 1,842 × 2,732 (72.52×107.56)		3,680 × 2,732 (144.88×107.56)	
	Machine weight	kg (lb) 8,500 (18,700)	8,700 (19,140)	17,000 (37,400)	17,400 (38,280)
CNC	OSP-P300LA, FANUC 0i-TF				

*1. Machine height and center height may become taller depending on attached cylinder type *2. Including tank, not including operation panel

Standard Specifications/Accessories

Item	V760EX	JIS A2-11	V920EX	JIS A2-11	Accessories
Spindle	V760EX	JIS A2-11 20 to 2,000 min ⁻¹	V920EX	JIS A2-11 20 to 1,250 min ⁻¹	Chuck open/close push button switch*1 ○
Motor spindle	30/22 kW (30 min/cont)		Jack screws, foundation pads		○
Turret	V12		In-machine work lamp		LED
Coolant tank. Parenthesis show V920EX	400 L (420 L)		Tool kit		○
Front door interlock	○		Auto front door open/close*2		Includes tape SW
Lubrication monitor	○		*1. Standard specifications on V760EX only *2. Standard specifications on V920EX only		

Chip conveyor types and applications

Name	Hinge type	Scraper type	Magnet scraper type	Hinge scraper type (With drum filter)
Application	● For steel	● For castings	● For castings	● For steel, castings, nonferrous metal
Features	● General use	● Magnet scraper more effective for sludge disposal ● Easy maintenance ● Blade scraper	● Effective with sludge ● Not suited for nonferrous metals	● Filtration of long and short chips and coolant
Shape				

Note: Machine platform may be necessary depending on the type of chip conveyor.

Machine Specifications

Item	Unit	V920EX		2SP-V920EX	
		L	M	L	M
Capacity	Max turning diameter	ø920 (36.22)			
	Max swing diameter	ø1,000 (39.37)			
	Swing on carriage	ø710 (27.95)			
	Max work length (height)	860 (33.86)			
	Max workpiece weight (w/ chuck)	1,200 (2,640) [When limited to 2,000 kg/200 min ⁻¹]			
	Height from floor to spindle nose*1	1,150 (45.28)			
Travel	X-axis travel	485 (19.09)			
	Z-axis travel	860 (33.86)			
	C-axis travel	Degrees	–	360 (minimum control angle 0.001)	–
Spindle	Spindle speed	20 to 1,250			
	Spindle speed ranges	2 auto ranges (2-speed motor coil switching)			
	Spindle nose shape	JIS A2-11			
	Spindle bore diameter	ø110 (4.33)			
	Spindle front bearing diameter	ø200 (7.87)			
Turret	Turret type	V12	M-V12	V12 + V12	M-V12 + M-V12
	No. of tools	12	L/M: 12	12 + 12	L/M: 12 + 12
	OD tool shank dimensions	□25, □32 (1, 1-1/4)			
	ID tool shank diameter	ø40, ø50, ø63 (1.57, 1.97, 2.48)			
Milling tool	Milling tool spindle speed	–	4,000/3,000 (inter/cont)	–	4,000/3,000 (inter/cont)
	Milling tool spindle torque	–	OSP: 125.6/42 (intermittent/cont)	–	OSP: 125.6/42 (intermittent/cont)
	Milling tool speed range	–	Infinitely variable	–	Infinitely variable
Feedrates	Rapid traverse X, Z-axis	m/min (fpm) X: 24 (78.74), Z: 24 (78.74)			
	Rapid traverse C-axis	–	20	–	20
	Cutting feedrate X, Z-axis	mm/rev 0.001 to 300.000			
Motor	Spindle drive	30/22 (40/30) (30 min/cont)		30/22 (40/30) (30 min/cont) × 2	
	Milling tool spindle motor	–	OSP: 5.6 (7.5) (cont) FANUC: 5.5 (7.3) (cont)	–	OSP: 5.6 (7.5) (cont) FANUC: 5.5 (7.3) (cont)
	Axis drive motors	OSP X: 3.5 (4.7), Z: 5.2 (6.9) FANUC X: 4.0 (5.3), Z: 5.0 (6.7)			
	Coolant pump motors (50 Hz/60 Hz)	Turret: 0.28/0.46 (0.37/0.61) shower: 0.39/0.62 (0.52/0.83)			
Machine Size	Machine height *1	mm (in.) 3,693 (145.39)			
	Required floor space (length × width) *2	mm×mm (in.) 2,252 × 2,845 (88.66×112.01) [3,302 × 2,845 (130.00×112.01)]*3		4,500 × 2,845 (177.17×112.01)	
	Machine weight	kg (lb) 11,400 (25,080)	11,700 (25,740)	22,800 (50,160)	23,400 (51,480)
CNC	OSP-P300LA, FANUC 0i-TF				

*1. Machine height and center height may become taller depending on attached cylinder type *2. Including tank, not including operation panel *3: With ATC specs

Optional Specifications and Accessories

Specifications	V760EX/2SP-V760EX	V920EX/2SP-V920EX
High-speed spindle (OSP)	25 to 2,500 min ⁻¹ 55/45 kW (30 min/cont)	–
High-speed spindle (FANUC)	25 to 2,500 min ⁻¹ 45/37 kW (30 min/cont)	–
High-torque spindle (OSP)	20 to 2,000 min ⁻¹ 30/22 kW (30 min/cont)	20 to 1,000 min ⁻¹ 45/37 kW (30 min/cont)
High-torque spindle (FANUC)		20 to 600 min ⁻¹ 30/22 kW (30 min/cont)
ATC specs	–	Tool storage capacity: 8, CAPTO C6 (cutting tools only)
Hydraulic power chuck (solid)	H01MA-15, 18, 21, 24	H01MA-24, 28, 32, 36
Manual chuck	3-jaw ø535, ø610 4-jaw ø500, ø600	ø610, ø710, ø800, ø915 ø600, ø700, ø800, ø915
Chuck-related	Chucking miss detection, auto chuck open/close w/confirm, chuck pressure high/low switch, chuck open/close foot pedal	
High pressure coolant	4.0 MPa, 7.0 MPa	
Raised machine height	50 mm, 100 mm, 150 mm	
Chip conveyor	Rear Hinge type, Scraper type, Magnet scraper, Drum filter Side Hinge type, Scraper type*, Magnet scraper* (* V760EX / 2SP-V760EX only)	
Chip bucket		
Auto front door open/close	Mechanical safety, tape SW, area sensor	Area sensor
Special coolant pump (50/60 Hz)	0.37/0.55 kW, 0.75 kW/1.5 kW	0.37/0.55 kW, 0.75 kW/1.5 kW, 3.0/3.0 kW
Shower/chip flusher coolant (50/60 Hz)	0.55/0.75 kW, 0.75/1.1 kW	0.55/0.88 kW, 0.73/1.21 kW
Coolant gun mounted (50/60 Hz)	0.55/0.75 kW	0.75/1.5 kW
Oil skimmer mounted	Belt system, Screw type	
Coolant sensors	Level detection (upper, lower)	
Air blower	chuck, turret	
Air gun mounted		
Mist collector		
Jib crane	100 kg, 200 kg	
In-process work gauging		
Touch setter	Manual axis, Auto/manual	
High accuracy specs	AbsoScale (OSP), scale feedback (FANUC) *X axis only Coolant temperature regulator (cooling only), Turcite® lining (X axis, Z axis)	
Automation specs	Robot setup, workpiece push-up device, workpiece ejector	

■ Standard Specifications

Basic Specs	Control	Turning: X, Z simultaneous 2-axis. Multitasking: X, Z, C simultaneous 3-axis
	Position feedback	OSP full range absolute position feedback (zero point return not required)
	Min / Max inputs	8-digit decimal, ±99999.999 to 0.001 mm (±3937.0078 to 0.0001 in.), 0.001°, Decimal: 1 μm, 10 μm, 1 mm (0.0001, 1 in.) (1°, 0.01°, 0.001°)
	Feed	Override: 0 to 200%
	Spindle control	Direct spindle speed commands (S4) override 50 to 200%, Constant cutting speed, optimum turning speed designate
	Tool compensation	Tool selection: 32 sets, tool offset: 32 sets
	Display	15-inch color display operational panel, multi-touch panel operations
	Self-diagnostics	Automatic diagnostics and display of program, operation, machine, and NC system problems
Operations	Program capacity	Program storage: 2 GB, operation buffer: 2 MB
	suite apps	Applications to graphically visualize and digitize information needed on the shop floor
	suite operation	Highly reliable touch panel suited to shop floors. One-touch access to suite apps.
	Easy Operation	"Single-mode operation" to complete a series of operations. Advanced operation panel/graphics facilitate smooth machine control
	Programming	Program management, edit, multitasking, scheduled programs, fixed cycles, special fixed cycles, tool nose R compensation, fixed drilling cycles, arithmetic functions, logic statements, trig functions, variables, branch statements, auto programming (LAP4), programming help
	Machineoperations	MDI, manual (rapid traverse, manual cutting feed, pulse handle), load meter, operations help, alarm help, sequence, return, manual interrupt & auto return, threading slide hold, data I/O, spindle orientation (electric)
	MacMan	Machining Management: machining results, machine utilization, fault data compile & report, external output
	Communications/Networks	USB ports, Ethernet
High speed/accuracy	Thermo Active Stabilizer-Construction (TAS-C)	Compensates for thermal deformation error in the machine structure due to ambient temperature changes
	High speed/accuracy	Hi-G control, Ethernet
Energy-saving function	ECO suite	ECO Idling Stop, ECO Power Monitor

■ Optional Specifications

Optional Specifications	NML		3D		OT-IGF		OTM	
	E	D	E	D	E	D	E	D
New Operations								
Advanced One-Touch IGF-L *2					●	●		
Advanced One-Touch IGF-L Multitasking *2							●	●
Programming								
Circular threading		●		●		●		●
Program notes		●		●		●		●
User task 2 I/O variables, 8 each								
Work coordinate systemsselect								
Tool compensation (Std: 32 sets)	10 sets							
	50 sets							
	100 sets							
	Tool compensation 64 sets							
Common variables 1,000 sets (Std: 200 sets)	Tool compensation 96 sets							
	Tool compensation 200 sets							
	Tool compensation 999 sets							
Thread matching (spindle orientation required)								
Threading slide hold (G34, G35)								
Variable spindle speed threading (VSST)								
Inverse time feed								
Milling machines pocs	Coordinate convert	▲	▲	▲	▲			●
	Profile generate	▲	▲	▲	▲			●
Monitoring								
Real 3-D simulation					●	●	●	●
Cycle time over check	●	●	●	●	●	●	●	●
Load monitor (spindle, feed axis)					●	●	●	●
Load monitor no-load detection (load monitor ordered)								
Tool life management		●		●		●		●
Tool life warning								
Operation end buzzer								
Chuck miss detection	Included in machine specs							
Work counters	Count only							
	Cycle stop							
	Start disabled							
Hour meters	Power ON							
	Spindle rotation							
	NC operating							
NC operation monitor (counter, totaling)	●	●	●	●	●	●	●	●
NC work counter (stops at full count with alarm)								
Status indicator (triple lamp) Type C [Type A, Type B]	●	●	●	●	●	●	●	●
Measuring								
In-process work gauging	Included in machine specs							
Z-axis automatic zero offset by touch sensor								
C-axis automatic zero offset by touch sensor								
Gauge data output	File output							
Post-process work gauging interface	Set levels (5-level, 7-level)							
	BCD							
Touch setter [M, A]	Included in machine specs							

Optional Specifications	NML		3D		OT-IGF		OTM	
	E	D	E	D	E	D	E	D
External Input/Output and Communication Functions								
RS-232-C connector								
DNC link	DNC-T3							
	DNC-C/Ethernet							
	DNC-DT							
USB (additional)	2 additional ports possible							
Automation/Untended Operation								
Auto power shutoff MO2, alarm								
Warmup function (by calendar timer)								
Tool retract cycle								
External program selections	A (pushbutton) 8 types							
	B (rotary switch) 8 types							
	C1 (digital switch) BCD, 2-digit							
	C2 (external input) BCD, 4-digit							
Third party robot and loader interface *3	Type B (machine)							
	Type C (robot and loader)							
	Type D							
Type E								
Cycle time reduction *3	Operation time reduction	●	●	●	●	●	●	●
High-Speed/High-Accuracy Functions								
Pitch error compensation								
AbsoScale detection *3								
Hi-Cut Pro	▲	▲	▲	▲			●	●
ECO suite (energy saving function)								
ECO Operation								
Other Functions								
Collision Avoidance System (CAS)								
One-Touch Spreadsheet								
Machining Navi L-g								
Harmonic spindle speed control (HSSC)	●	●	●	●	●	●	●	●
Spindle dead-slow cutting								
Spindle speed setting								
Manual cutting feed								
Spindle power peak cutting								
Short circuit breaker								
External M signals [2 sets, 4 sets, 8 sets]								
Edit interlock								
OSP-VPS (virus protection system)								
Illumination in control panel								
Air conditioning in control panel								
AC 100V 1A plug								

*1. NML: Normal, 3D: Real 3D simulation, OT-IGF: One-Touch IGF, OTM: One-Touch M
 E: Economy, D: Deluxe
 *2. Real 3-D Simulation included
 *3. Engineering discussions required.
 Note: ▲ Triangle items for M function (milling tool) machines only.

■ Standard Specifications

No. of controlled axes	2 simultaneous axes with X and Z axes, 3 simultaneous axes with multitasking on X, Z, and C axes.	Program input	Program memory capacity 512KB
	Interpolation system		Positioning, straight line, taper, arc, threading, taper
Fine coordinate interpolation, Cylindrical interpolation (M spec only)			Chamfering/corner radius
Command system	Parallel absolute incremental command		Complex shape fixed cycle (I+II)
Minimum input increment	Both X, Z axes 0.001 mm		Extension program editing
Min command value	±99999.999 mm, decimal point input		USB memory input/output (program input/output only)
Operating panel	10.4 in color LCD		Custom macro
Monitoring	Display language: English / Japanese		Custom macros, additional common variables (total is 500)
	Operating time, no. of parts display		Programmable data input
	Electronic buzzer		High-speed skip
	Graphic display	Program protection key switch	
Machine operations	Constant peripheral speed control	Compensation	Background editing
	Spindle orientation (1 point, M19)		Fixed drilling cycle (M spec)
	Continuous threading		Inch/metric conversion
Machine operations	Constant peripheral speed control		Thermal deformation compensation
	Spindle orientation (1 point, M19)		Nose-radius comp
Continuous threading	Constant peripheral speed control		tool dimensions/wear compensation
Machine operations	Spindle orientation (1 point, M19)		Tool compensations (64/system)
	Continuous threading		AI contouring control I

■ Optional Specifications

Monitor	Tool counter	
	Work counter	
	Multi-counter	
	Hour meters	
	Status indicator	3-step
Machine operations	Tool life management	Okuma software Spare tool jump
	Abnormal load detection	Spindle + feed axes
	Oriented spindle stop	4-point (M19, 119, 129, 139)
Program input	Auto power shut-off	
	Circuit breaker	
	External program selection	Digital switch with 2-digit indicator
	System selection Tool compensation	G54 to G59
	Program restart	
Automation	Spare M codes	2 pts, 4 pts, 8 pts
	Memory type pitch error compensation	
	Robot interface	
Other	RS-232-C input/output connector	
	Illumination in control panel	LED
	Air conditioning within control panel	Temperature regulator (cooler only), dehumidifier
	AC 100V 1A plug	In operation panel, control panel

Spindle output/torque diagram (Optional)

V760EX/2SP-V760EX

Standard spindle (FANUC)

- Speed 2,000 min⁻¹
- Max output 30/22 kW (30 min/cont)
- Max torque 1,290/946 N-m (30 min/cont)

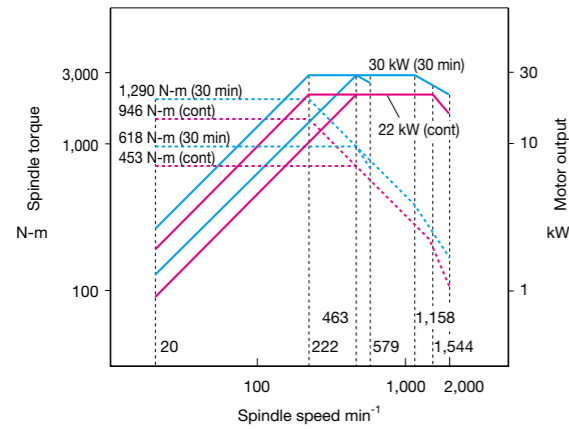

High-torque spindle (OSP)

- Speed 2,000 min⁻¹
- Max output 30/22 kW (30 min/cont)
- Max torque 2,840/2,082 N-m (30 min/cont)

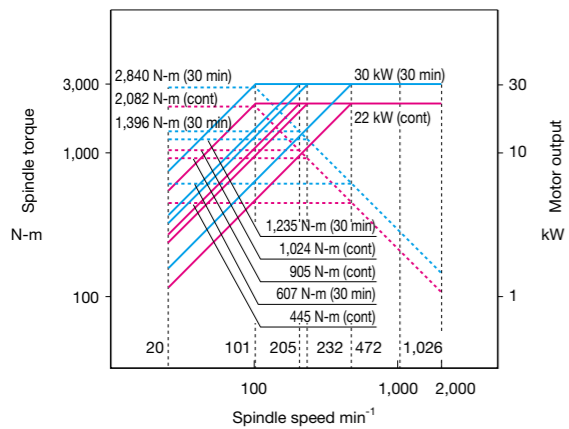

High-torque spindle (FANUC)

- Speed 2,000 min⁻¹
- Max output 30/22 kW (30 min/cont)
- Max torque 2,910/2,140 N-m (30 min/cont)

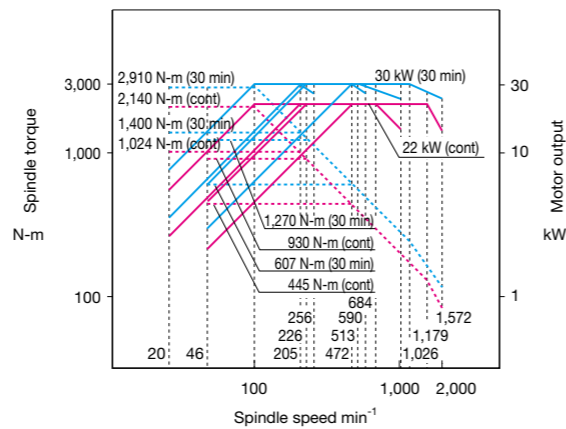

High-speed spindle (OSP)

- Speed 2,500 min⁻¹
- Max output 55/45 kW (30 min/cont)
- Max torque 834/682 N-m (30 min/cont)

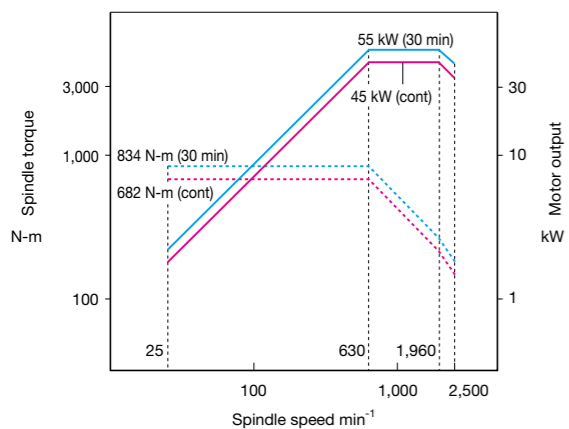

High-speed spindle (FANUC)

- Speed 2,500 min⁻¹
- Max output 45/37 kW (30 min/cont)
- Max torque 516/423 N-m (30 min/cont)

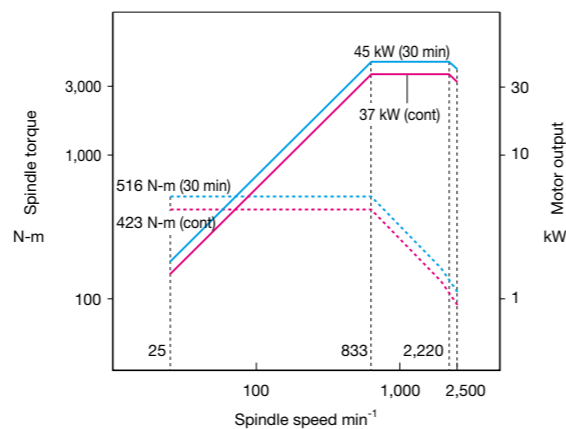

V920EX/2SP-V920EX

Standard spindle (FANUC)

- Speed 1,250 min⁻¹
- Max output 30/22 kW (30 min/cont)
- Max torque 2,608/1,608 N-m (30 min/cont)

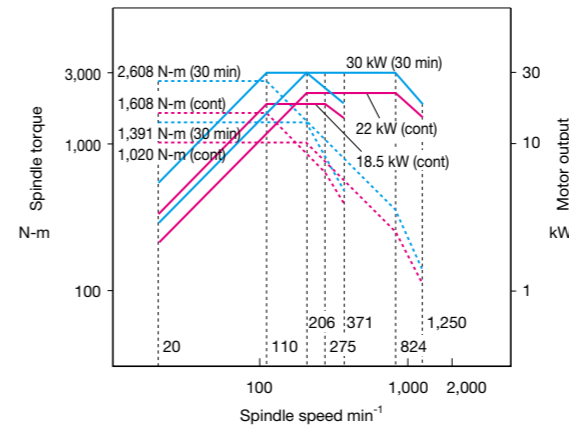

High-torque spindle (OSP)

- Speed 1,000 min⁻¹
- Max output 45/37 kW (30 min/cont)
- Max torque 5,319/4,373 N-m (30 min/cont)

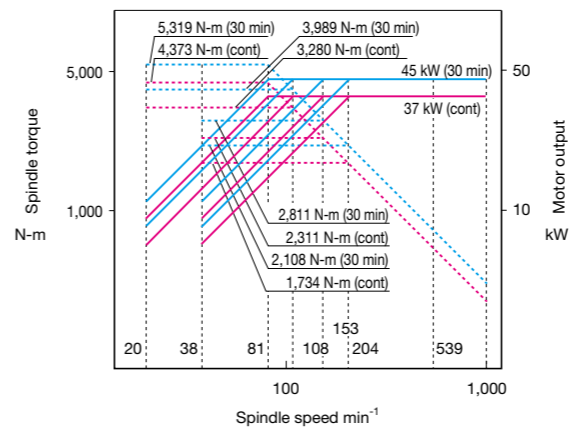

High-torque spindle (FANUC)

- Speed 600 min⁻¹
- Max output 30/22 kW (30 min/cont)
- Max torque 5,264/3,246 N-m (30 min/cont)

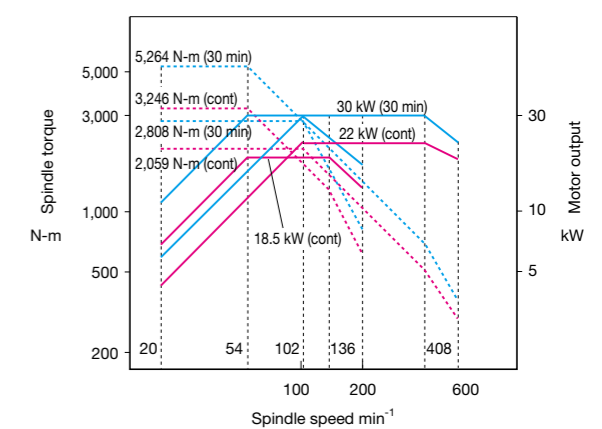

Milling tool spindle output/torque diagram (FANUC)

V760EX/2SP-V760EX

- Speed 4,000 min⁻¹
- Max output 5.5 kW (cont)
- Max torque 70/30 N-m (Intermittent/cont)

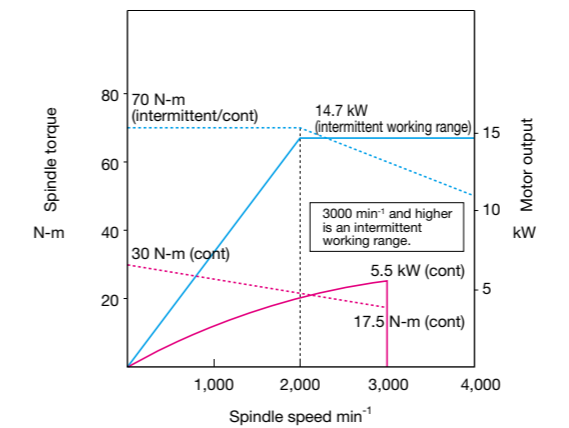

V920EX/2SP-V920EX

- Speed 4,000 min⁻¹
- Max output 5.5 kW (cont)
- Max torque 115/40 N-m (Intermittent/cont)

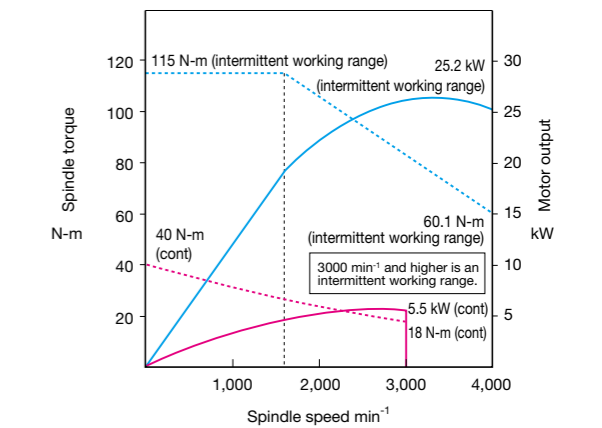

Tooling System
V760EX/2SP-V760EX

Unit: mm

Tooling kit
V760EX/2SP-V760EX

	Turning turret
OD-I25	6
OD-II25	3
OD-III25	2
ID-H40	6
BS 12-H40	2
BS 16-H40	2
BS 20-H40	2
BS 25-H40	2
DS MT No.1-H40	1
DS MT No.2-H40	1
DS MT No.3-H40	1
DS MT No.4-H40	1

V12 turret

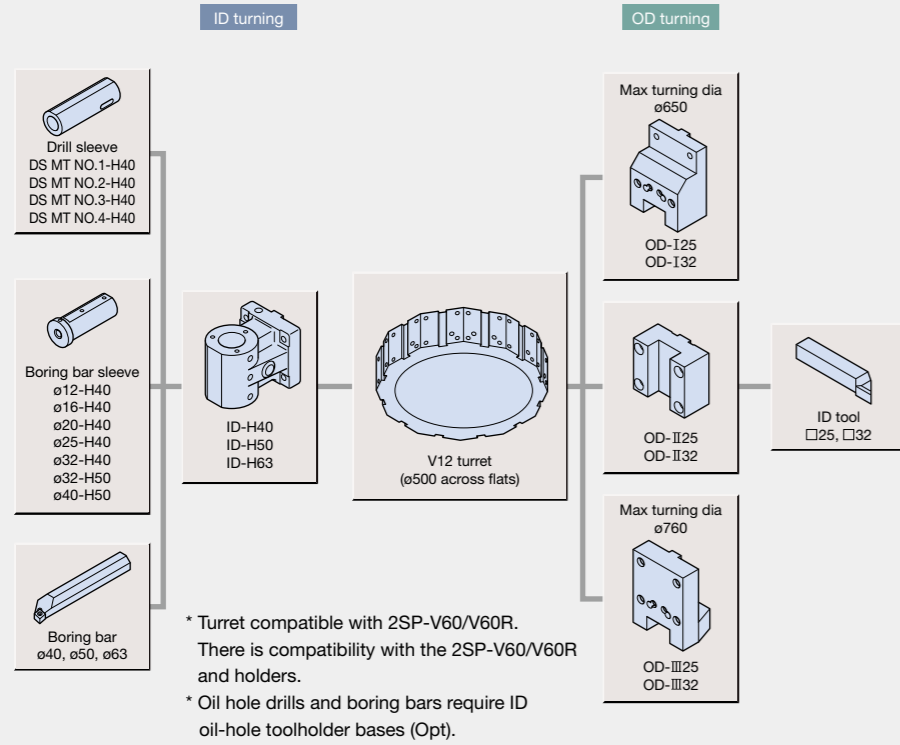

Unit: mm

Tooling System
V920EX/2SP-V920EX

Unit: mm

Tooling kit
V920EX/2SP-V920EX

	Turning turret
OD-I25	6
OD-II25	3
OD-III25	2
ID-H40	6
BS 12-H40	2
BS 16-H40	2
BS 20-H40	2
BS 25-H40	2
DS MT No.1-H40	1
DS MT No.2-H40	1
DS MT No.3-H40	1
DS MT No.4-H40	1

V12 turret

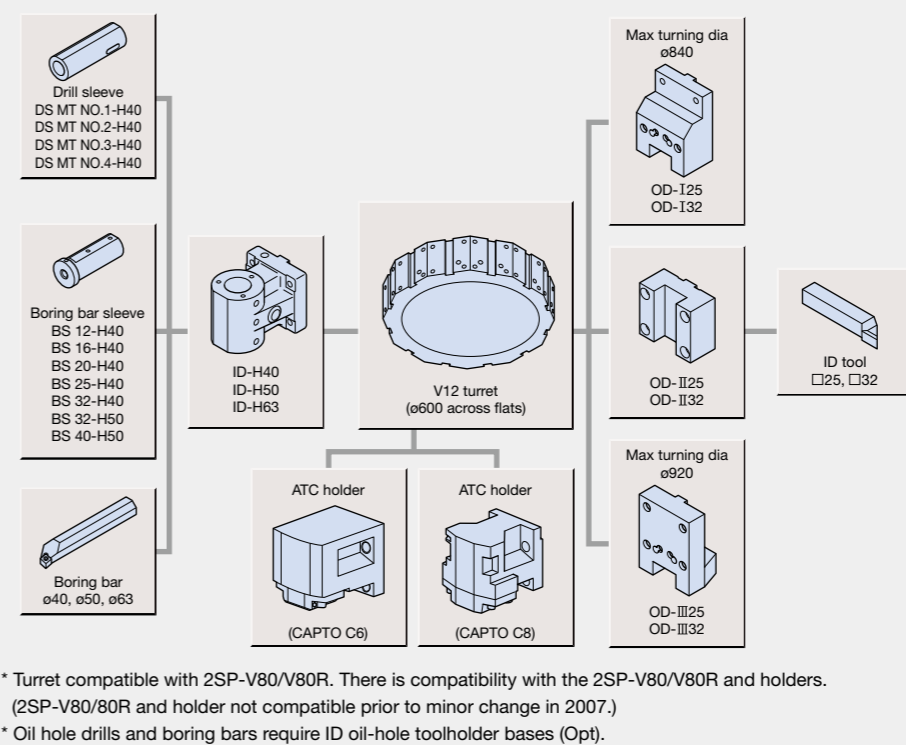

Unit: mm

M-V12 turret

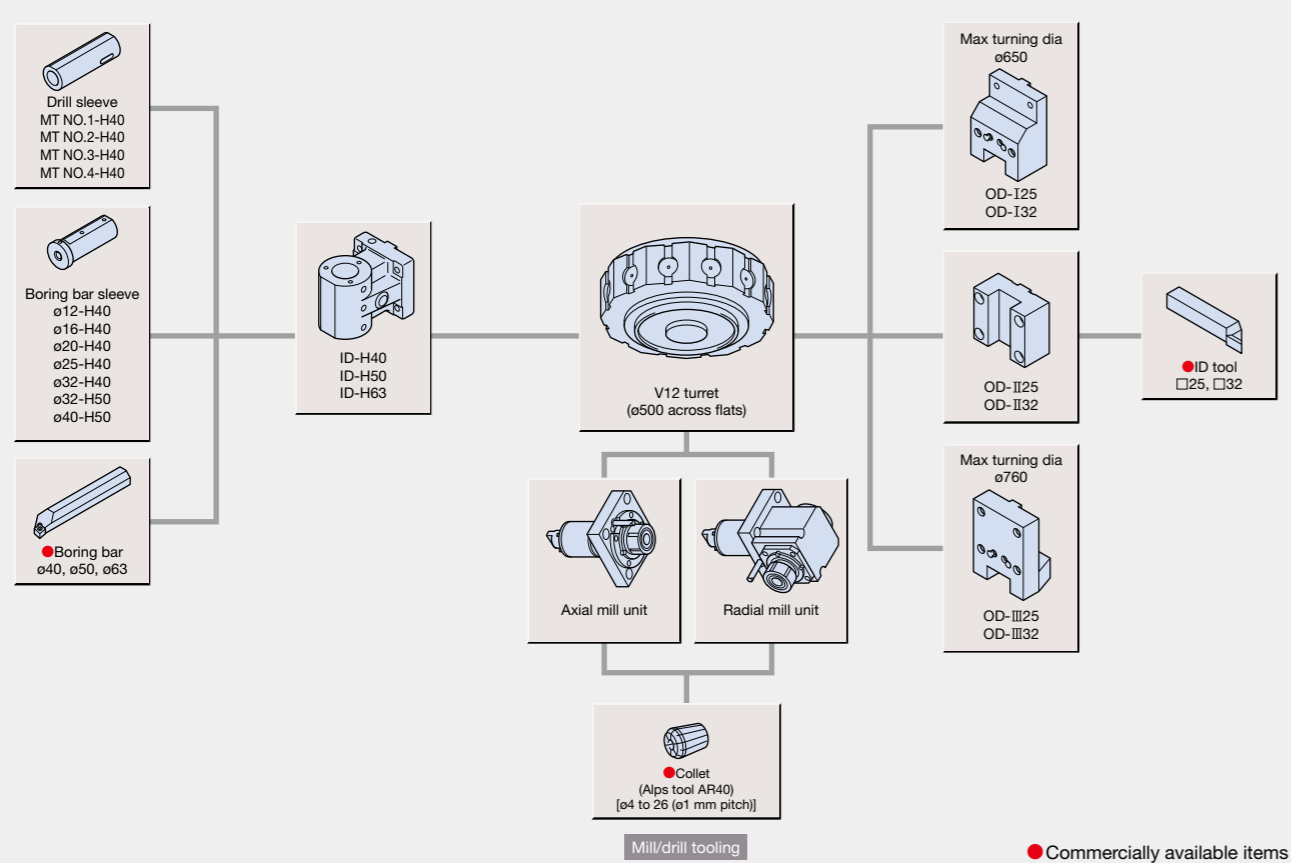

M-V12 turret

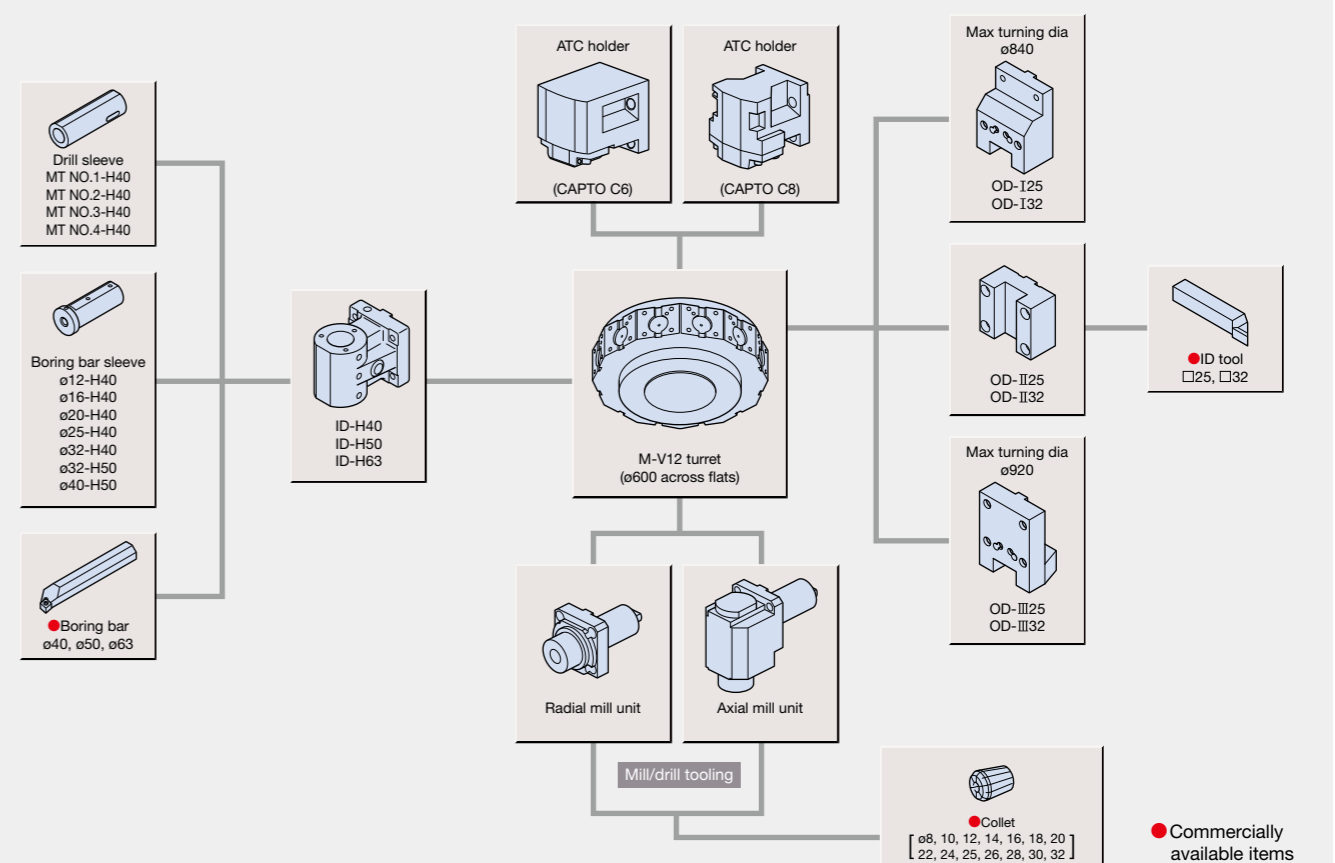

■ Working Ranges
V760EX/2SP-V760EX

Unit: mm

■ V12 turret

<OD toolholder>

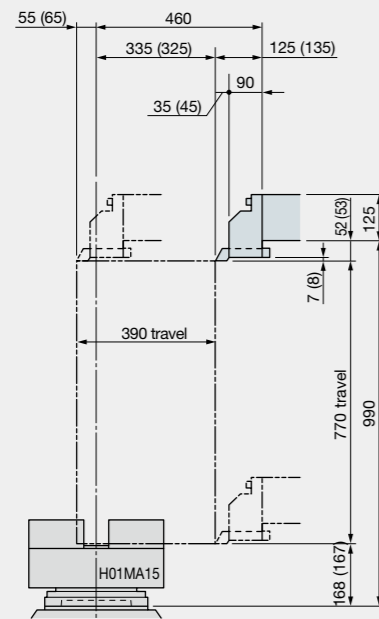

OD toolholder OD-I25
() : OD-I32

<ID toolholder>

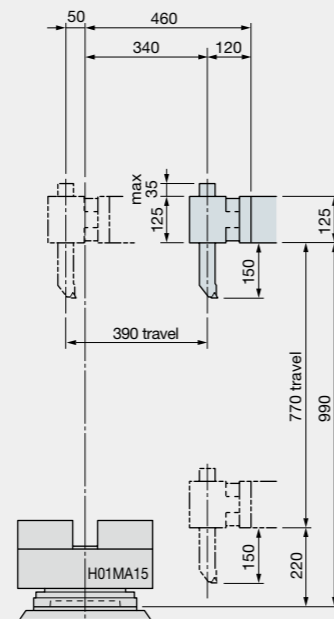

ID toolholder ID-H40
ID-H50
ID-H63

■ M-V12 turret

<Axial mill toolholder>

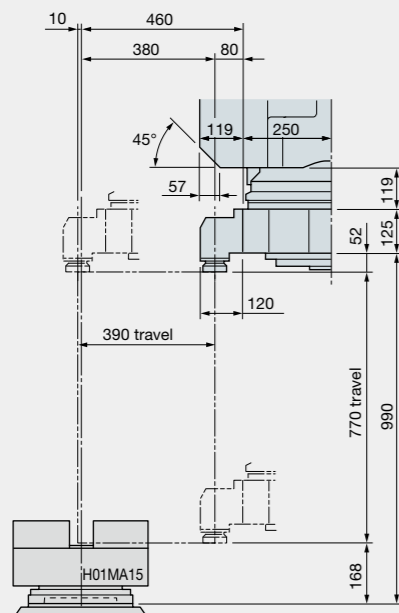

<Radial mill toolholder>

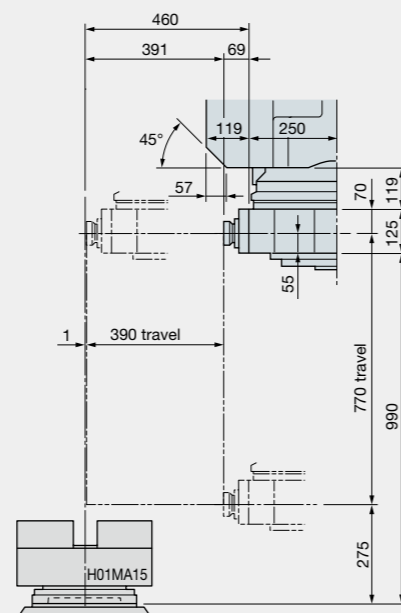

*The V12 turret and V12 multitasking turret have different shapes.

V920EX/2SP-V920EX

Unit: mm

■ V12 turret

<OD toolholder>

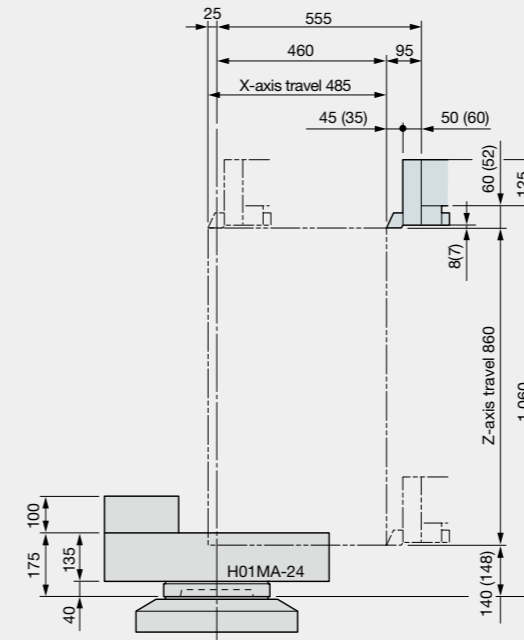

OD toolholder OD-III32
() : OD-III25

<ID toolholder>

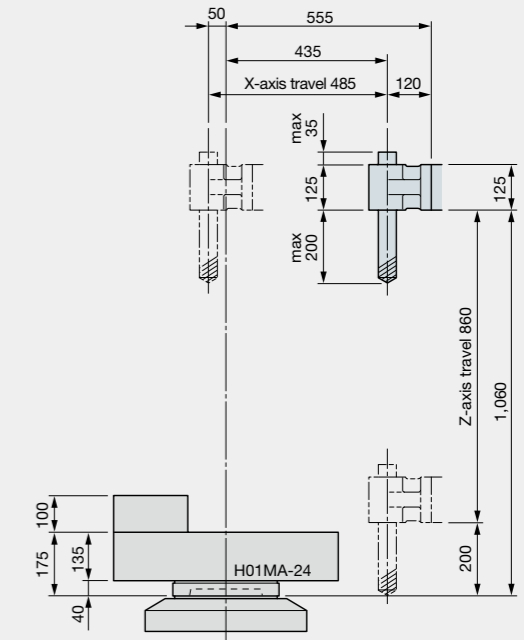

ID-H40
ID-H50
ID-H63

■ M-V12 turret

<Axial mill toolholder>

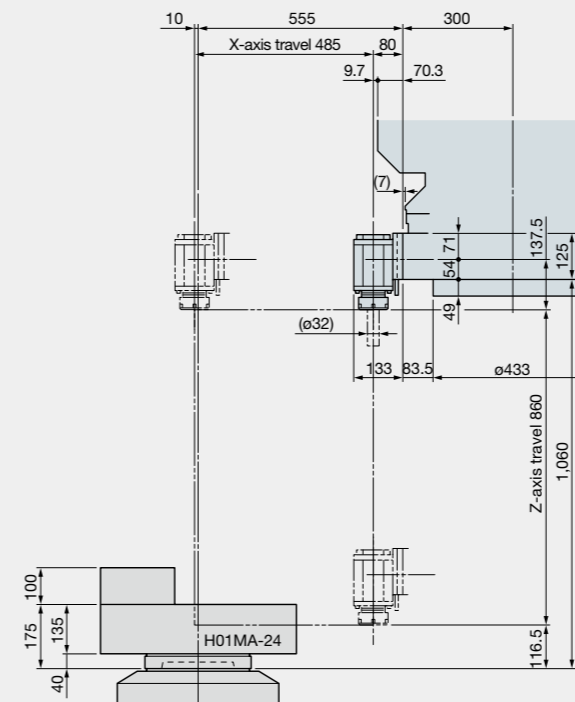

<Radial mill toolholder>

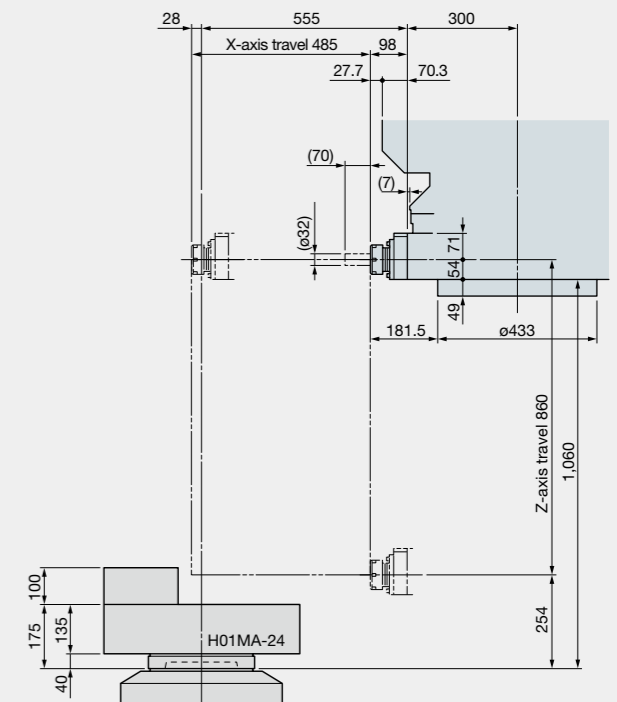

*For both multitasking turret and ATC specs.

■ Dimensional and Installation Drawings

V920EX

Unit: mm (in.)

■ ATC specs

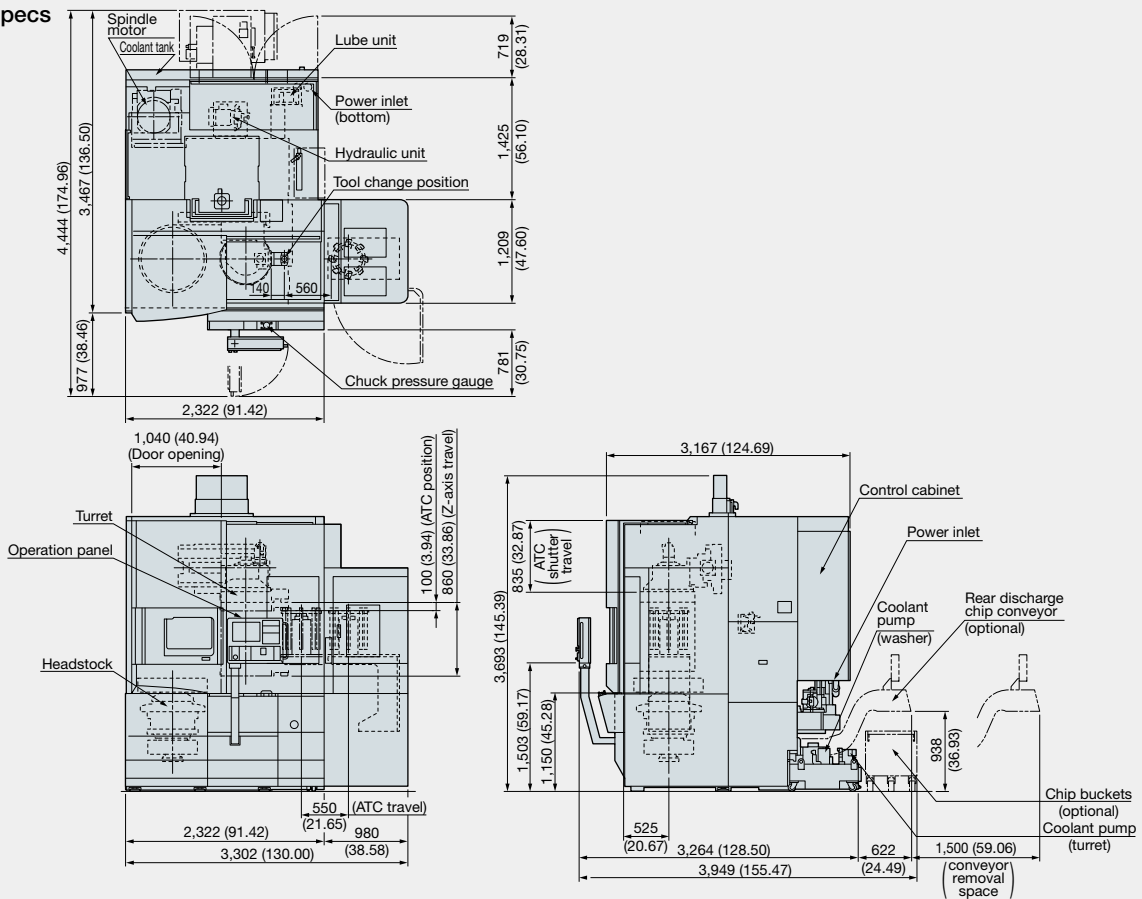

When using Okuma products, always read the safety precautions mentioned in the instruction manual and attached to the product.

● The specifications, illustrations, and descriptions in this brochure vary in different markets and are subject to change without notice.
Pub. No. V760/920EX-E-(1a)-300 (Jul 2018)



OKUMA Corporation

Oguchi-cho, Niwa-gun,
Aichi 480-0193, Japan
TEL: +81-587-95-7825 FAX: +81-587-95-6074

This product is subject to the Japanese government Foreign Exchange and Foreign Trade Control Act with regard to security controlled items; whereby Okuma Corporation should be notified prior to its shipment to another country.